

RECOIL

6.5" 2-Way SPEAKER SYSTEM

- 6.5" / 165 mm Component And Coaxial Speaker
- High Heat Dissipation / Over Sized Magnets Utilized
- 1.2" / 30.5mm MidBass (RAM65) Pure SV Voice Coil Wound on Kapton
- 1" / 25.4mm MidBass (RAX65) Pure SV Voice Coil Wound on Kapton
- 1" / 25.4mm Silk Soft Dome Tweeter(RAM65)
- 0.8" / 20.4mm Silk Soft Dome Tweeter(RAX65)
- Low Resonance Silk Dome Tweeter

RAM65 / RAX65 SPEAKER SYSTEM

RECOIL

www.RecoilAudio.com

COPYWRITE© 2020 RECOIL ALL RIGHTS RESERVED. RECOIL, AVS INDUSTRIAL CO. LTD AND DOMESTIC INVESTMENT GROUP, LLC ASSUME NO RESPONSIBILITY OR LIABILITY FOR FINES OR DAMAGES INCURRED AS A RESULT OF IMPROPER USE OF THIS PRODUCT.

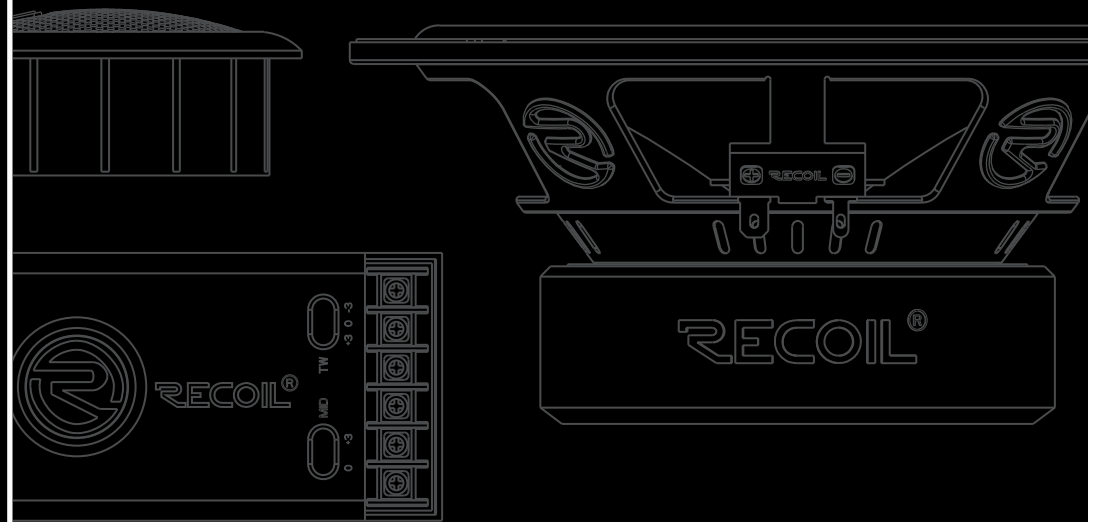

Introduction

Congratulations!

Thank you for purchasing our products. Recoil is committed to doing everything ourself. Becoming a geek company of car audio. We are very happy that you have chosen our products. With years of accumulated design knowledge, dedication to manual craftsmanship, and strong rigorous testing procedures; We have created and produced a rich product line that fulfills all your musical needs. The need for speakers to be smooth and clear, thats what Recoil strives for. For the best experience, we recommend that you choose a Professional installer to help you install your Recoil products.

NOTE: In case of accident, please read the warranty description of your product carefully, please keep your receipt and the original packaging of the product.



WARNING: To prevent damage to the equipment and any other possible injury, disconnect the battery from the power source before installation.

Features

RAM65

- 6.5"/166mm Woofer
- IMPP/Carbon Fiber Cone
- Aluminum Dustcap
- 25mm Silk Dome Tweeter
- Pure SV Voice Coil Wound on Kapton
- Ferro - Fluid Cooled Tweeter
- Powerful NdFeB Magnet
- High Performance Polyester Capacitor
- MidBass and Tweeter loudness can be adjusted separately

RAX65

- 6.5"/166mm Woofer
- IMPP/Carbon Fiber Cone
- 20mm Silk Dome Tweeter
- Pure SV Voice Coil Wound on Kapton;
- Ferro - Fluid Cooled Tweeter
- Powerful NdFeB Magnet
- High Quality Electrolytic Capacitor

1

RAM65/RAX65 Thiele/Small Parameters

MODEL	RAM65	RAX65
Nominal Diameter	6.5" (166mm)	6.5" (166mm)
Voice Coil Diameter	1.2" (30.5mm)	1.0" (25.5mm)
Impedance (DCR)	3.2 Ω	3.2 Ω
Fs - Free Air Resonance	50 - 20KHz	55-22kHz
(RMS/PEAK)	70W/150W	60W/130W
Qts	0.6	0.6
Qes	0.67	0.65
Qms	7.26	6.6
Equivalent Volume (Vas)	0.58ft ³ (16.5L)	0.42ft ³ (11.8L)
Sensitivity (1W / 1M)	87dB	88dB
Xmax	0.157" (4mm)	0.157" (4mm)

Features

Each RECOIL crossover has a tweeter and midbass attenuation located on the cover. Choose "+3","0" or "-3dB". If the tweeter is significantly closer to the listener than the midrange, this adjustment should improve the frequency level balance. Choose "0" or "180" degrees of polarity by reversing the wiring "+" and "-". This adjustment may improve frequency response depending on the tweeter mounting location relative to the midrange. Distance is "Time" and Phase effects this depending on dimension. We can also adjust the "+3" and "0" switch to lower the midbass level according to your tastes.

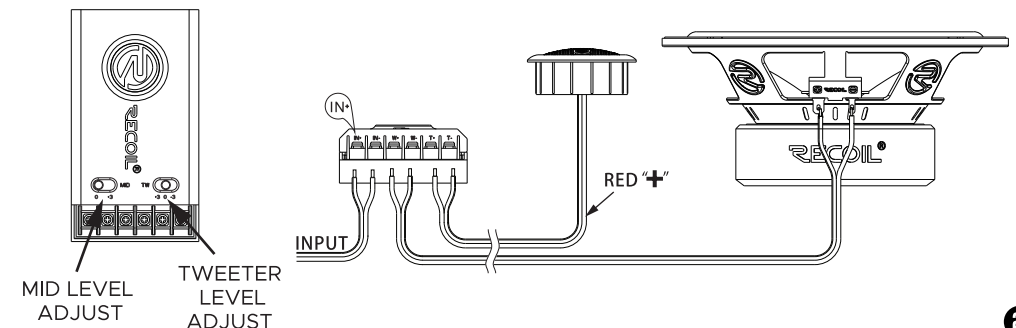

2

Woofers mounting

Installation of Front Door Speakers:

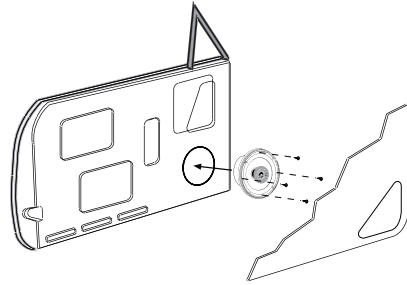

Installation of Rear Speakers:

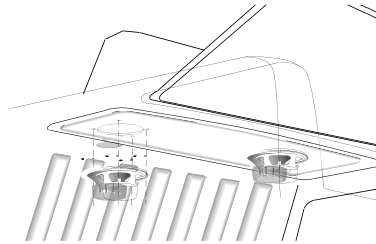

Dimensions

RAM65

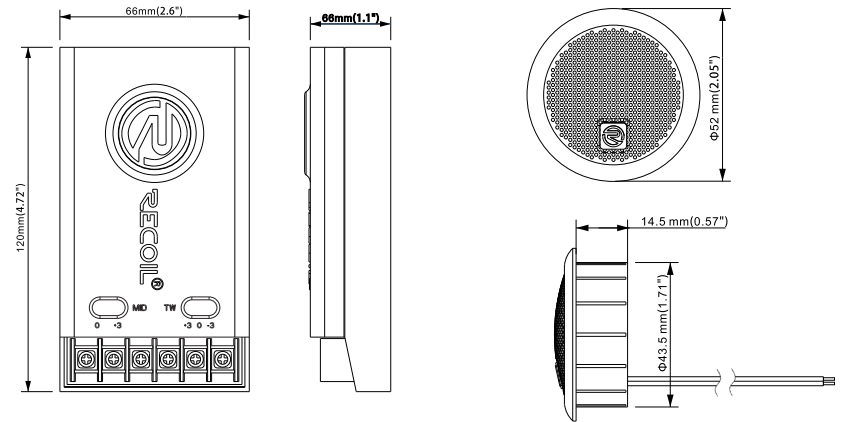
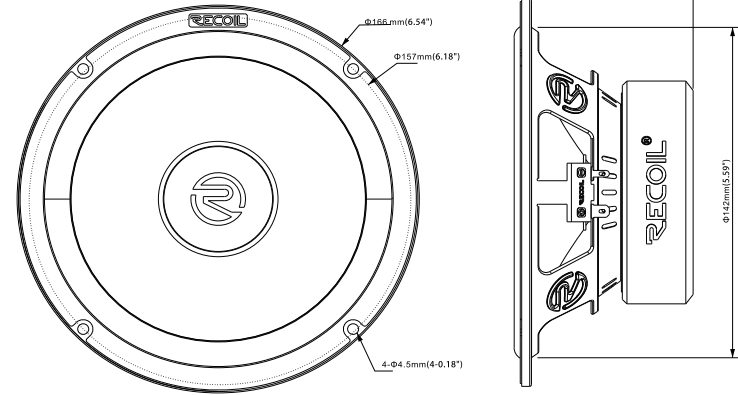

Tweeter Mounting

FRONT MOUNT TOP OF DOOR "SAILS"

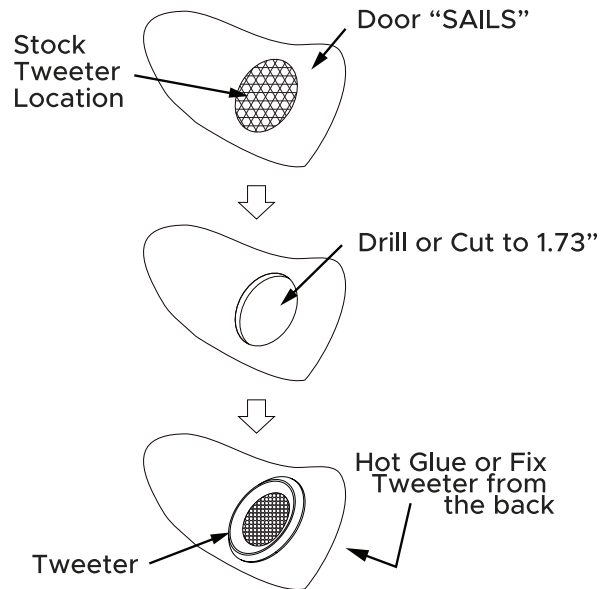

RAX65

